

DIES FOR CHAMPION DEPOSITORS **MODELS 65S/ETL, 65DT/ETL, 95S**

On the following pages are illustrations of all the standard dies available for the Champion wire - cut depositor machines.

The illustrations on the following pages are shown full size and represent the actual size of the opening in the die. Each illustration also indicates the number of openings in the die, as well as the part number of the die itself.

We have additional "special dies" available. We are also continuously producing new dies for our customers. If you require a "special die", please send us a detailed sketch or full description and actual size, so we can fabricate it for you.

All Champion extruder / depositor dies are produced of rustless aluminum alloy. Dies may be furnished with jumble centers to help control the center thickness of the product, if needed.

The actual size of the baked cookie, of course, will depend upon the cookie dough formulation, baking temperature, etc. The "spread" between the size of the cut cookie and the final baked product, then, also depends upon formulation and baking temperature and baking time.

16" WIDE EXTRUDER / DEPOSITOR DIES

(ALL ILLUSTRATION ACTUAL SIZE)

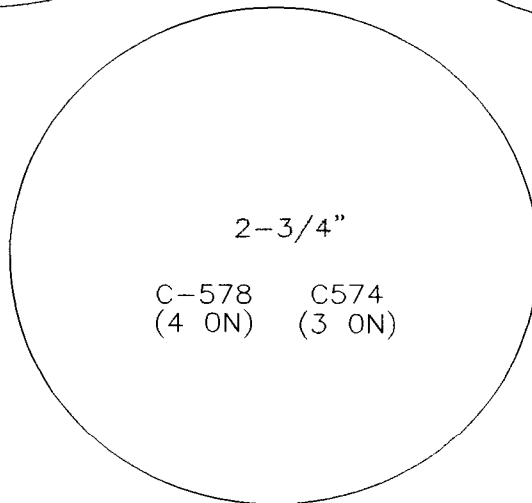
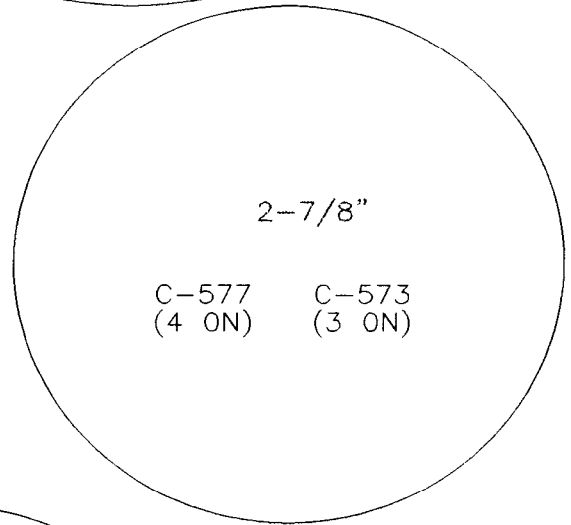
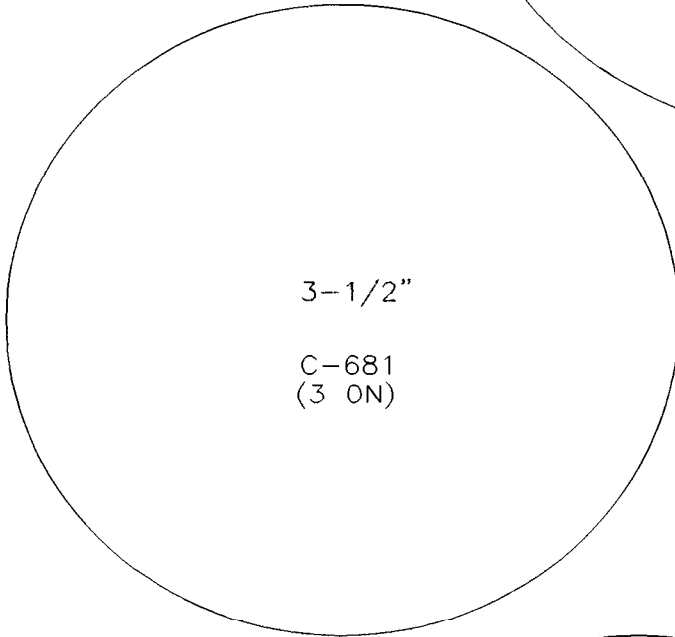
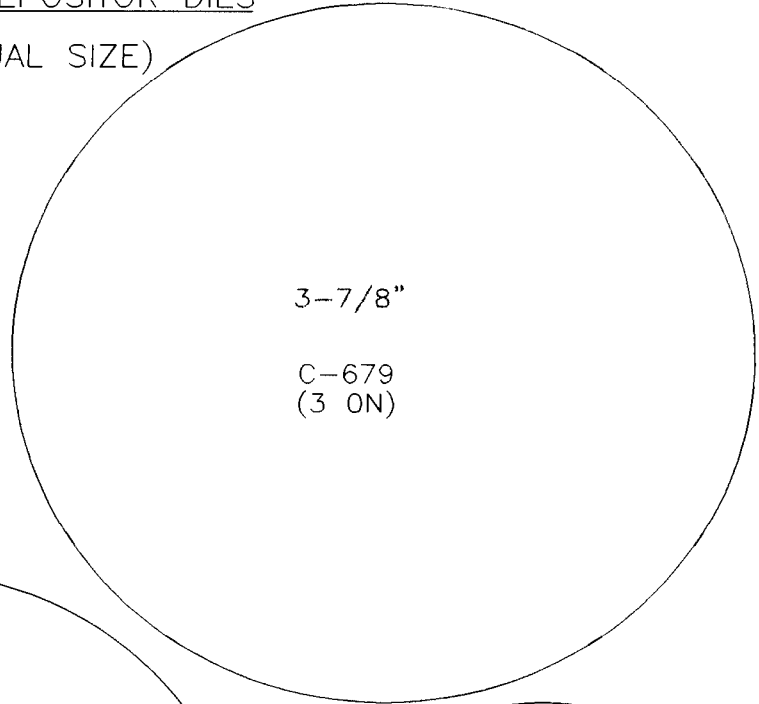

16" WIDE EXTRUDER / DEPOSITOR DIES
(ALL ILLUSTRATION ACTUAL SIZE)

2-7/16"

C-575 (3 ON) 5-3/8"CC	C-576 (3 ON) 4-3/16"CC
C-675 (4 ON)	

2-3/8"

C-680 (5 ON)	C-612 (4 ON)
-----------------	-----------------

2-1/4"

C-678 (3 ON)	C-579 (4 ON)
-----------------	-----------------

2"

C-580 (4 ON)	C-583 (5 ON)
-----------------	-----------------

1-7/8"

C-669 (4 ON)

1-3/4"

C-582 (4 ON)

1-1/2"

C-587 (6 ON)	C-588 (5 ON)
-----------------	-----------------

1-1/4"

C-589S (6 ON)

1-1/8"

C-584 (5 ON) C-591 (7 ON)

1-1/16"

C-581 (4 ON)

1"

C-585 (5 ON)	C-589 (6 ON)
C-684 (7 ON)	C-593 (9 ON)

7/8"

C-594 (11 ON)
C-586 (5 ON)

3/4"

C-677 (8 ON)
C-590 (6 ON)

5/8"

C-595 (12 ON)	C-590 (6 ON)
C-592 (7 ON)	

16" WIDE EXTRUDER / DEPOSITOR DIES

(ALL ILLUSTRATION ACTUAL SIZE)

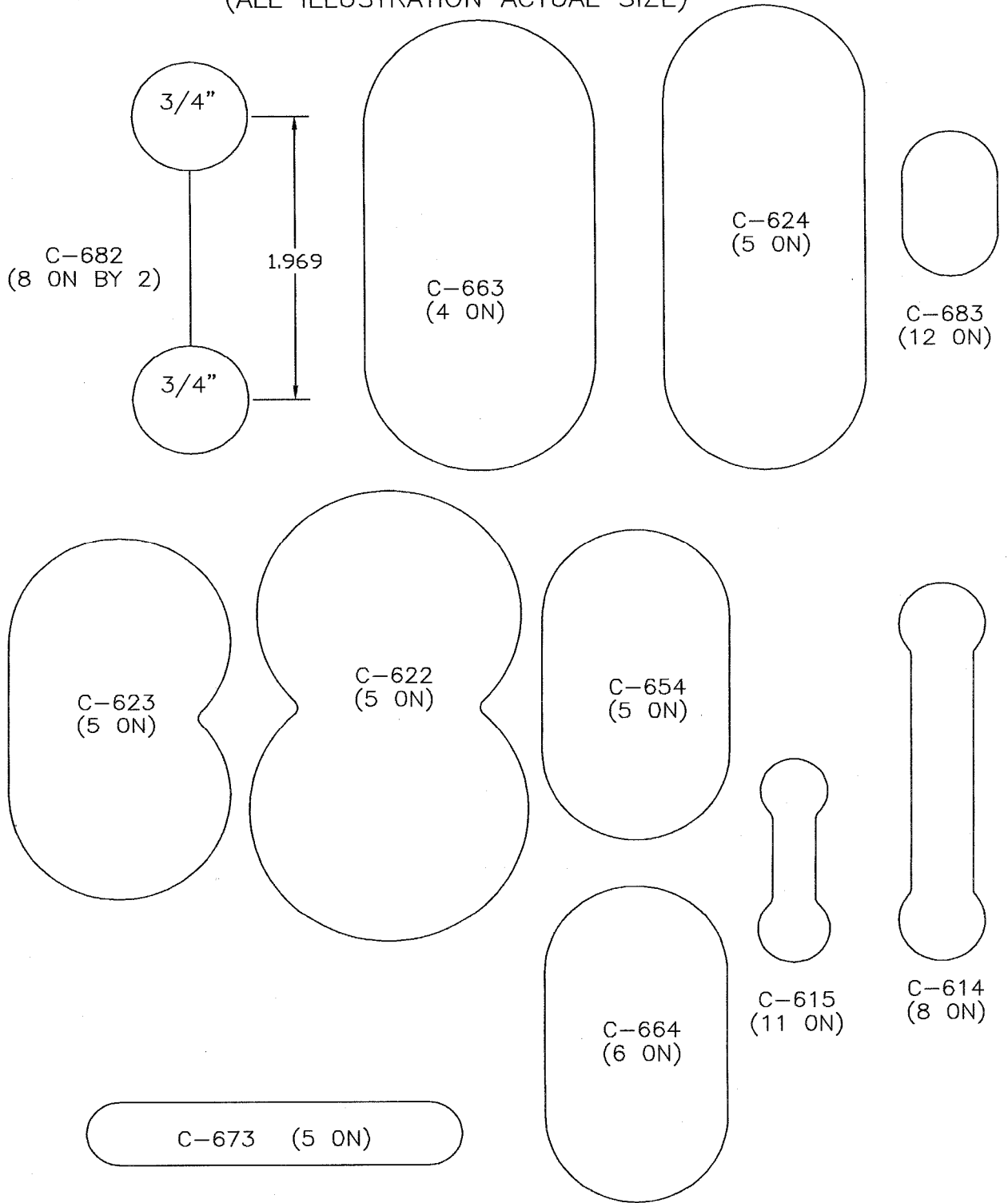

16" WIDE EXTRUDER / DEPOSITOR DIES
(ALL ILLUSTRATION ACTUAL SIZE)

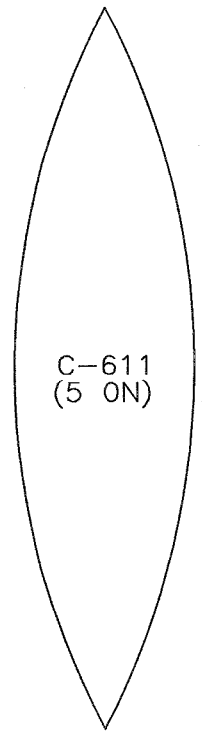
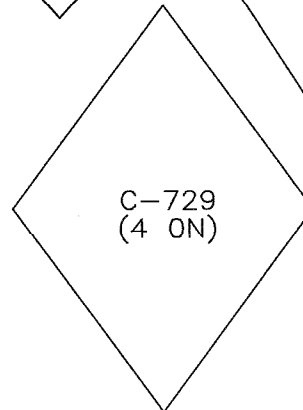
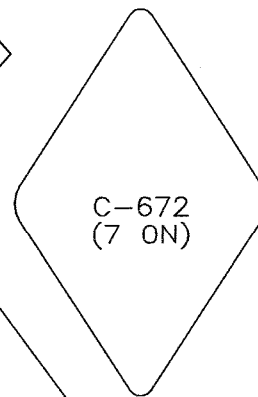
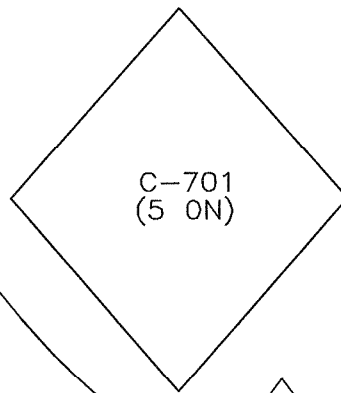
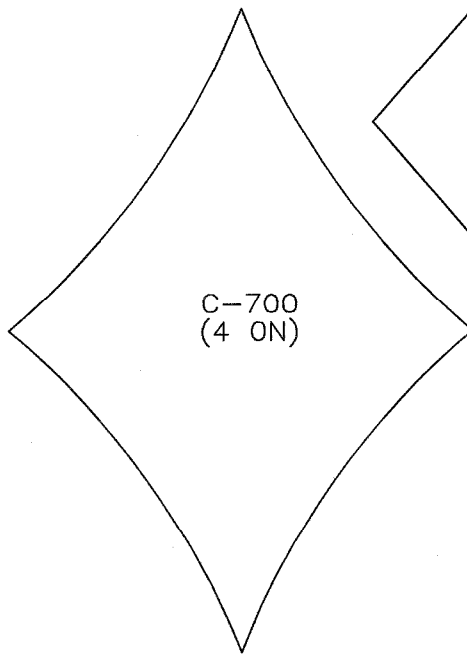
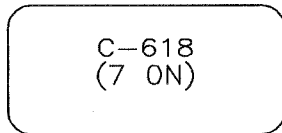
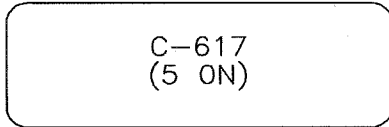
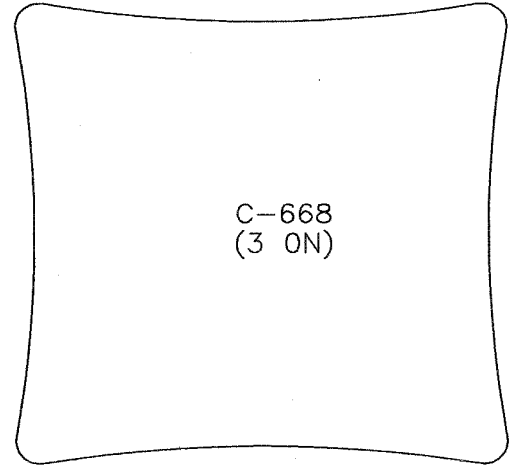
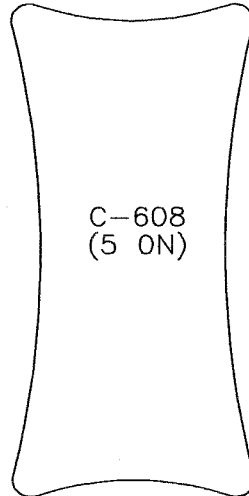
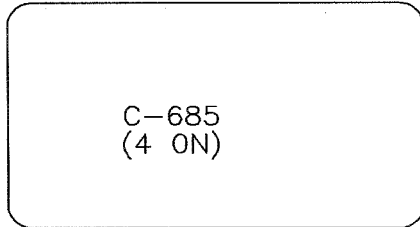
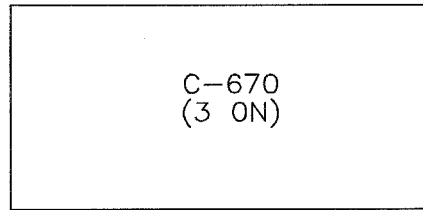
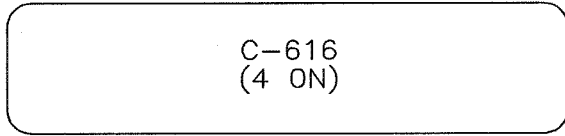

16" WIDE EXTRUDER / DEPOSITOR DIES
(ALL ILLUSTRATION ACTUAL SIZE)

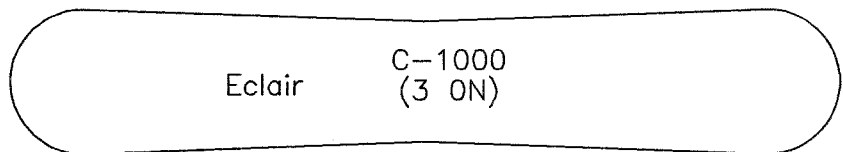
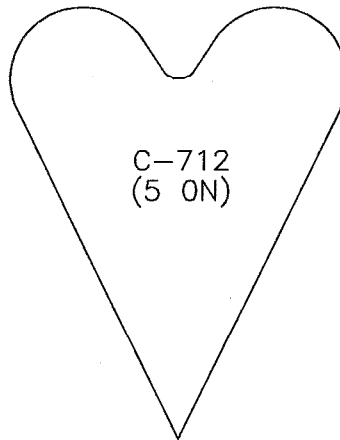
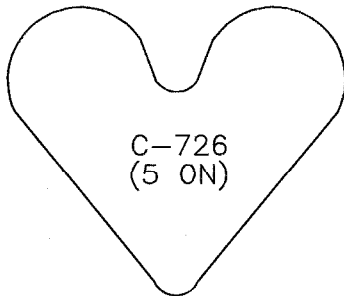
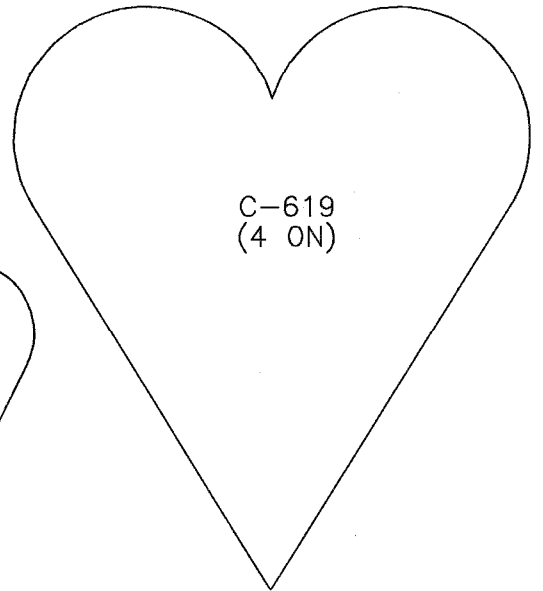
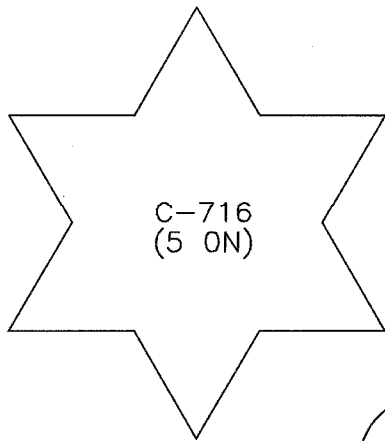
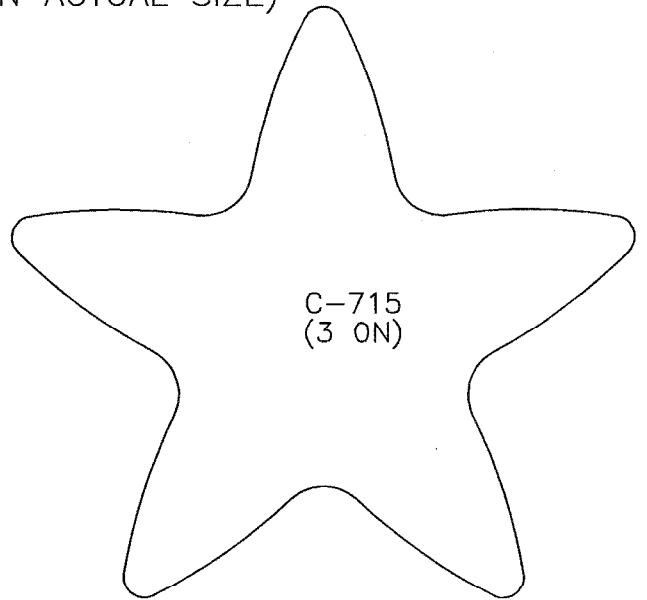
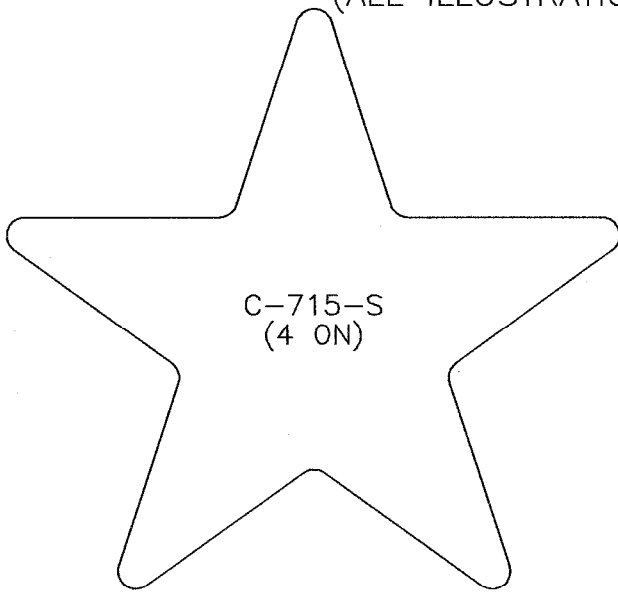

16" WIDE EXTRUDER / DEPOSITOR DIES
(ALL ILLUSTRATION ACTUAL SIZE)

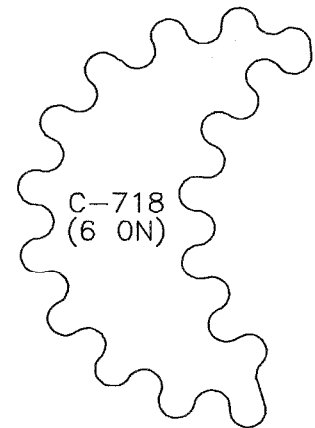
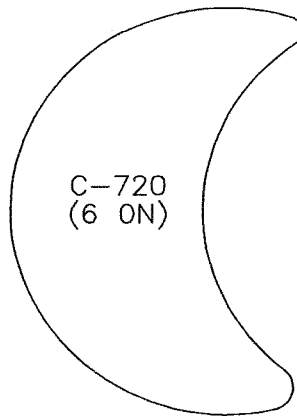
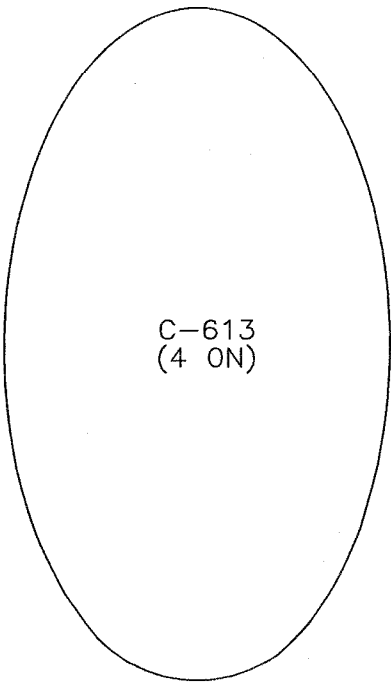
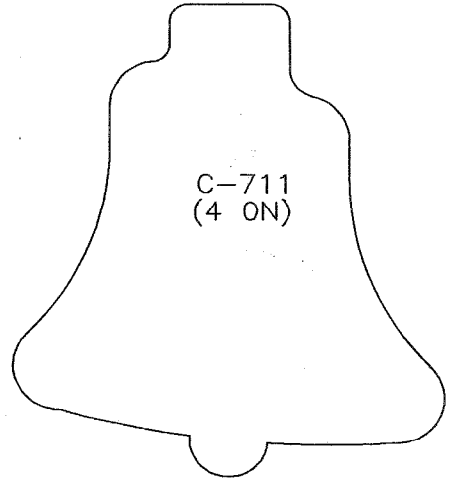
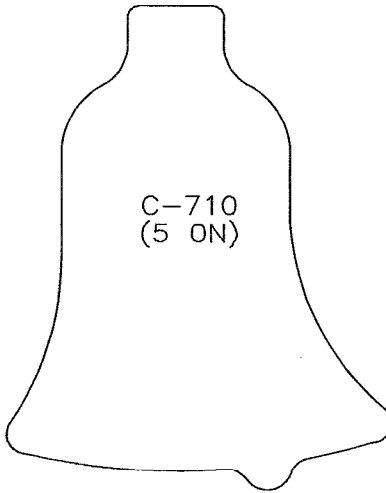
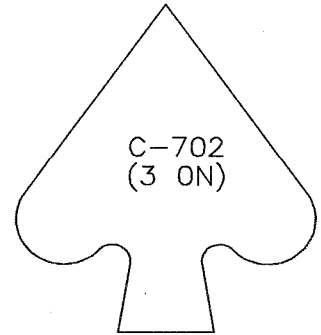
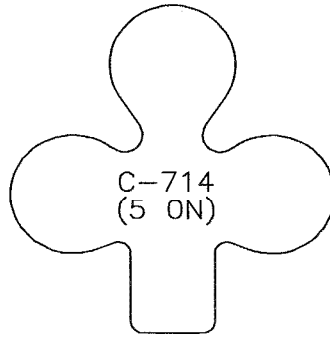
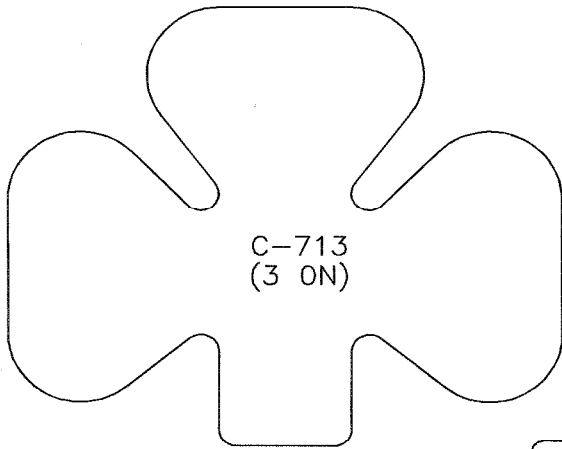

16" WIDE EXTRUDER / DEPOSITOR DIES
(ALL ILLUSTRATION ACTUAL SIZE)

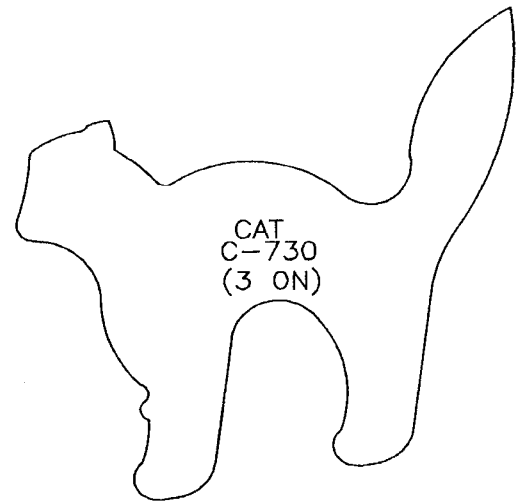
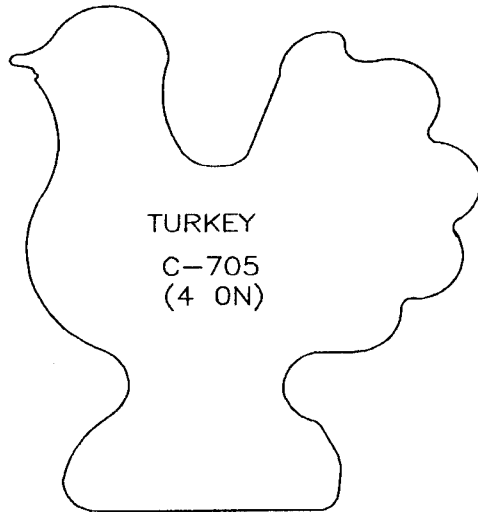
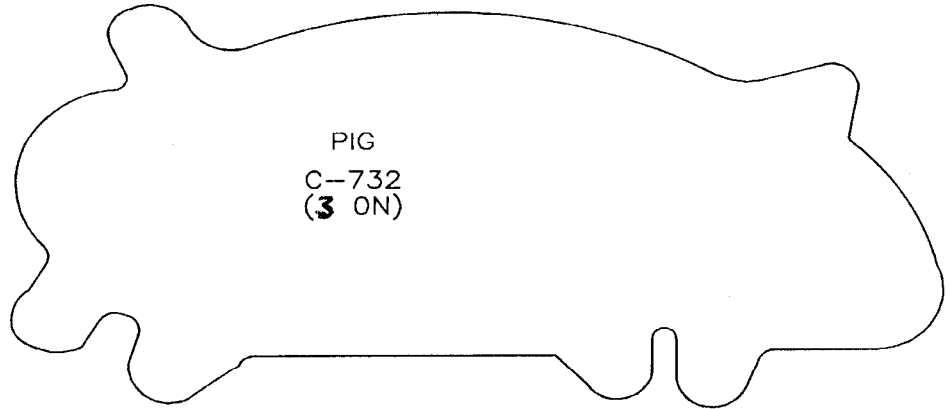
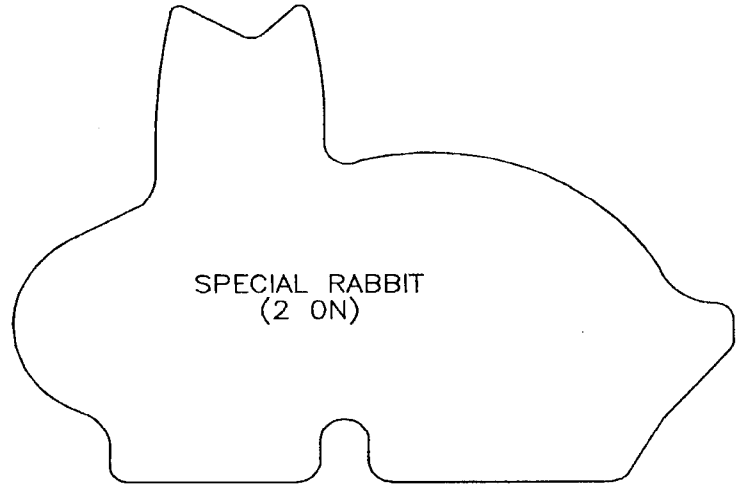
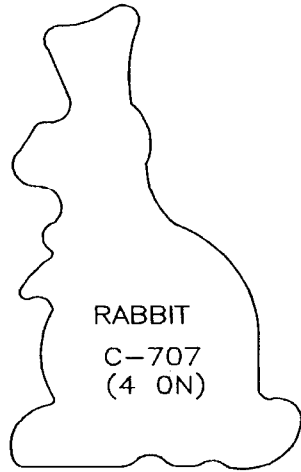

16" WIDE EXTRUDER / DEPOSITOR DIES
(ALL ILLUSTRATION ACTUAL SIZE)

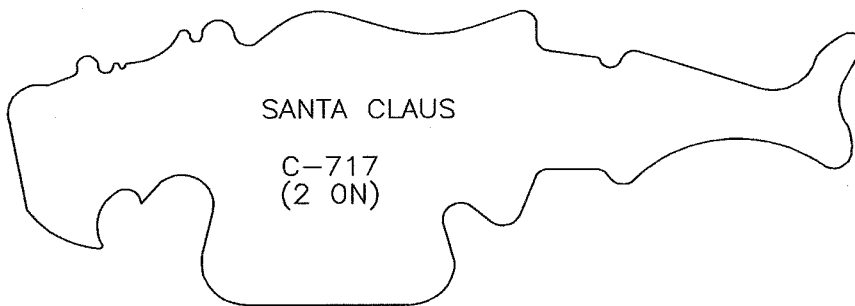
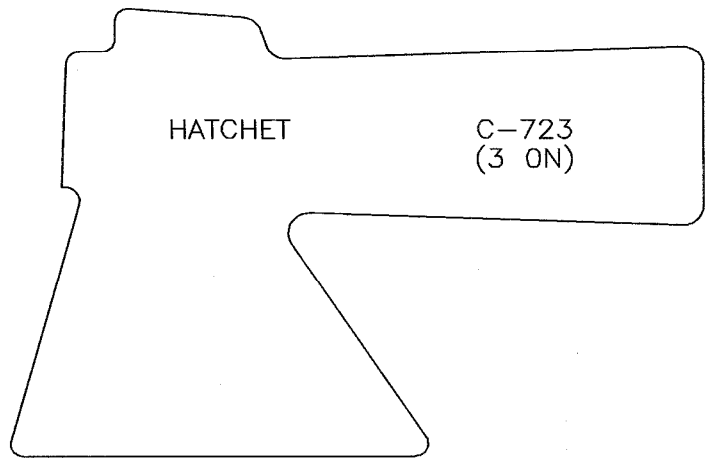
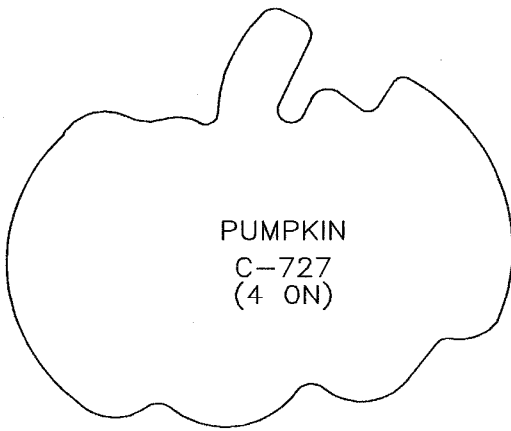
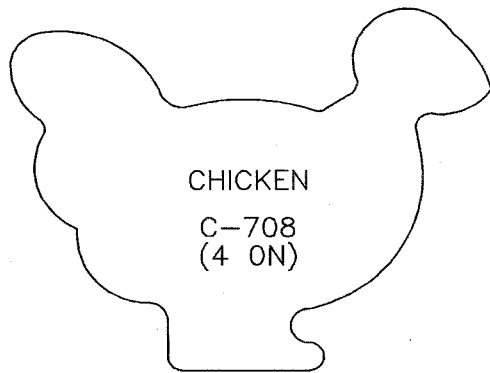
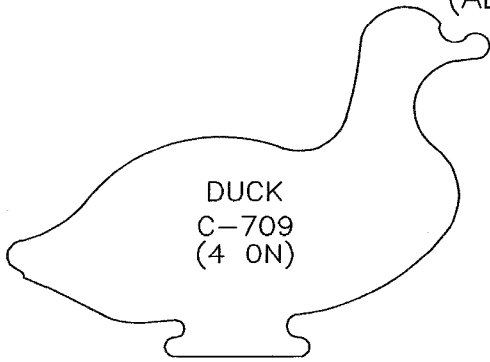

16" WIDE EXTRUDER / DEPOSITOR DIES
(ALL ILLUSTRATION ACTUAL SIZE)

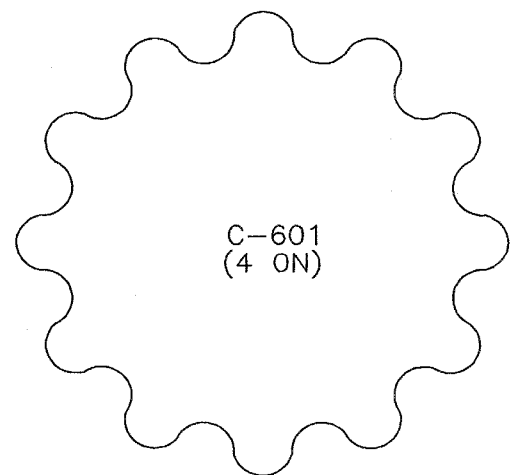
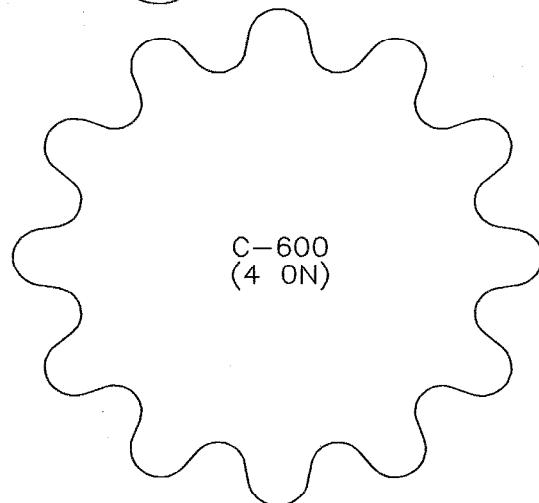
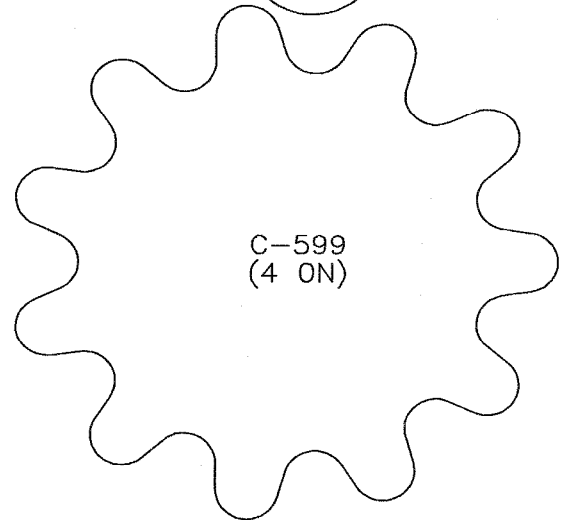
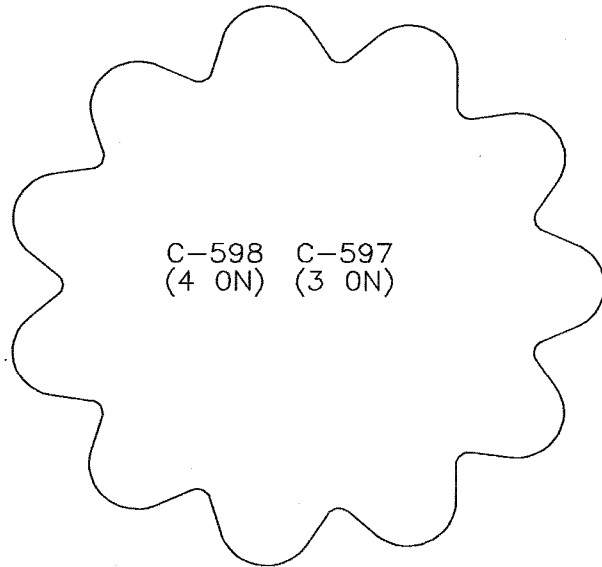
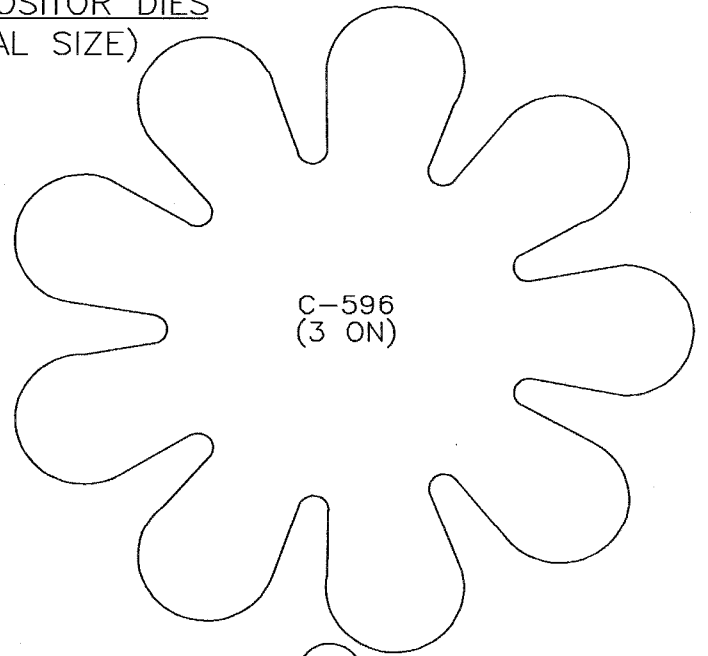

16" WIDE EXTRUDER / DEPOSITOR DIES
(ALL ILLUSTRATION ACTUAL SIZE)

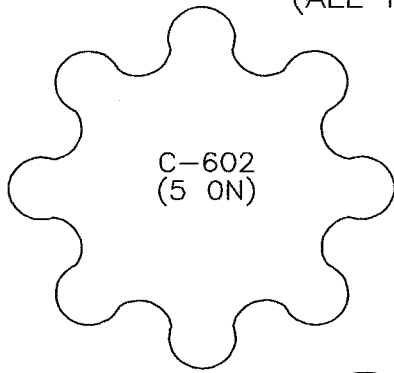

C-602
(5 ON)



C-725
(5 ON)

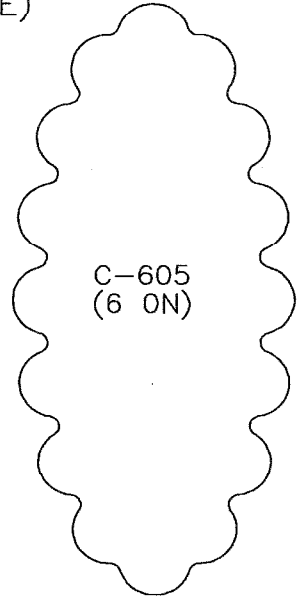

C-605
(6 ON)

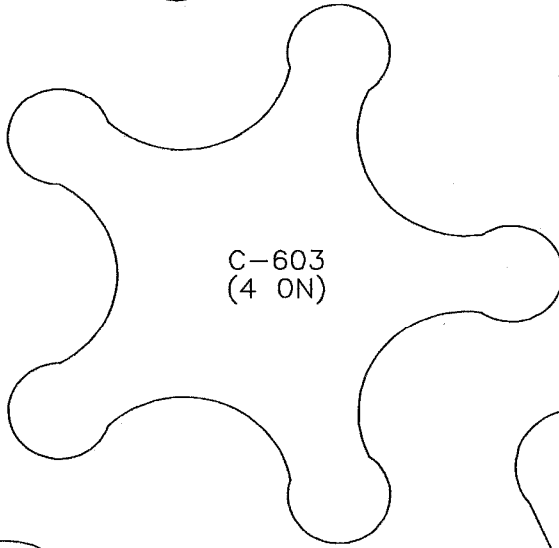

C-603
(4 ON)

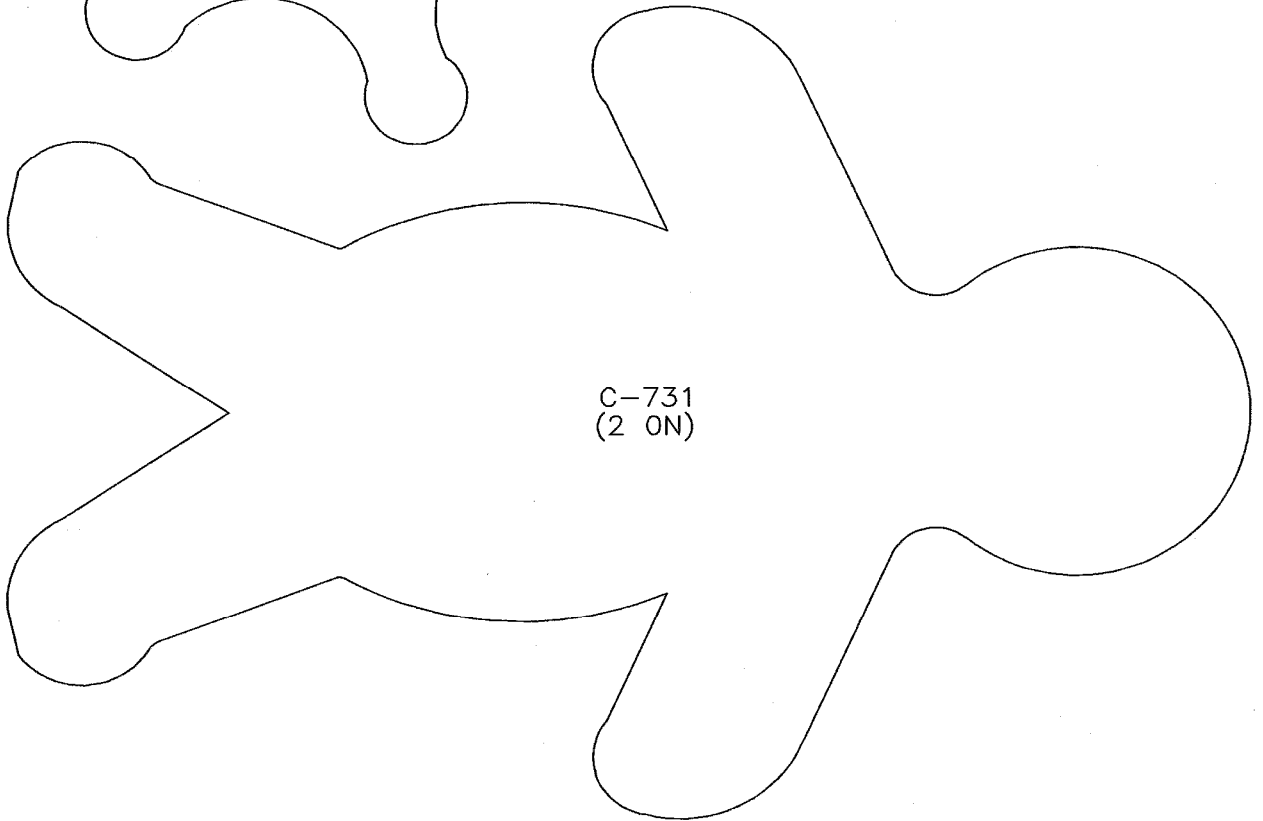

C-731
(2 ON)

16" WIDE EXTRUDER / DEPOSITOR DIES

(ALL ILLUSTRATION ACTUAL SIZE)

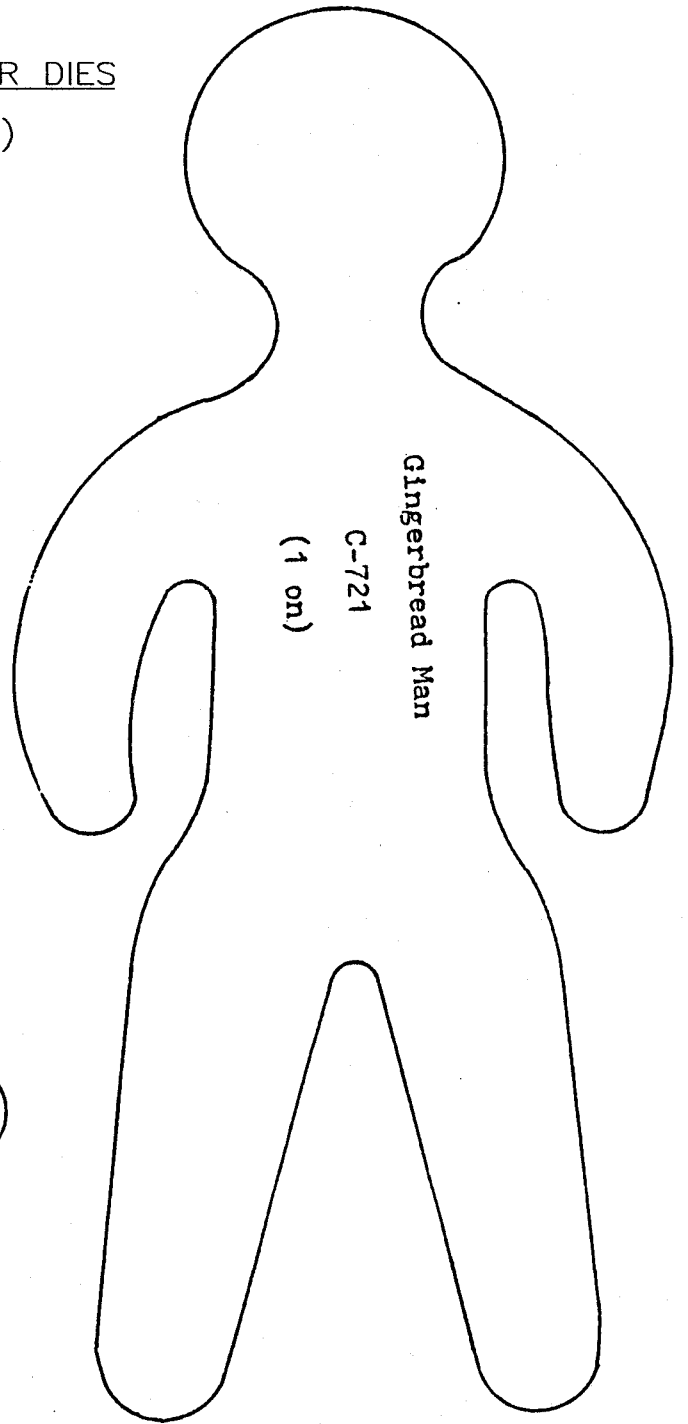
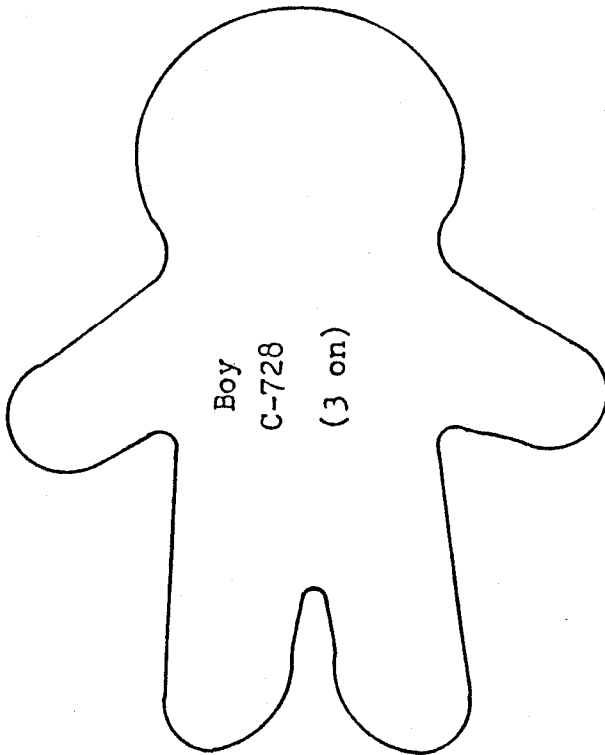

16" WIDE EXTRUDER / DEPOSITOR DIES

(ALL ILLUSTRATION ACTUAL SIZE)

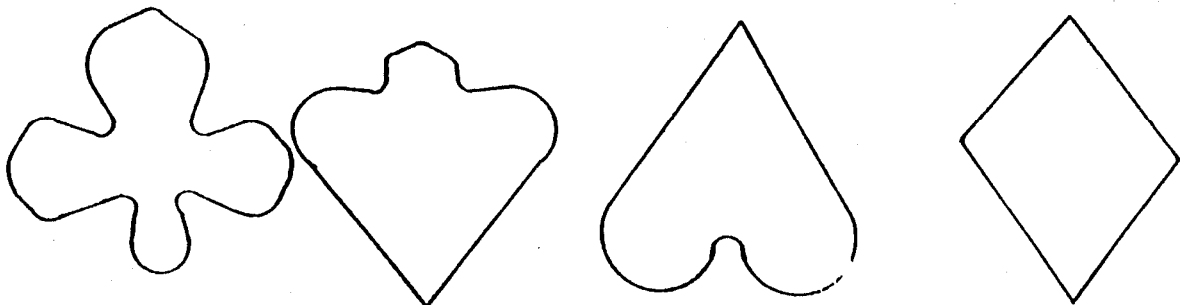
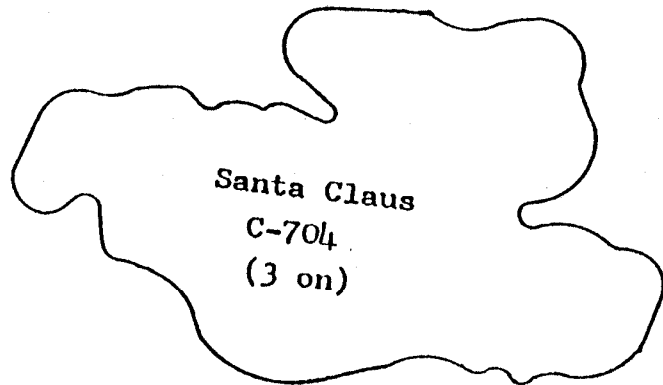
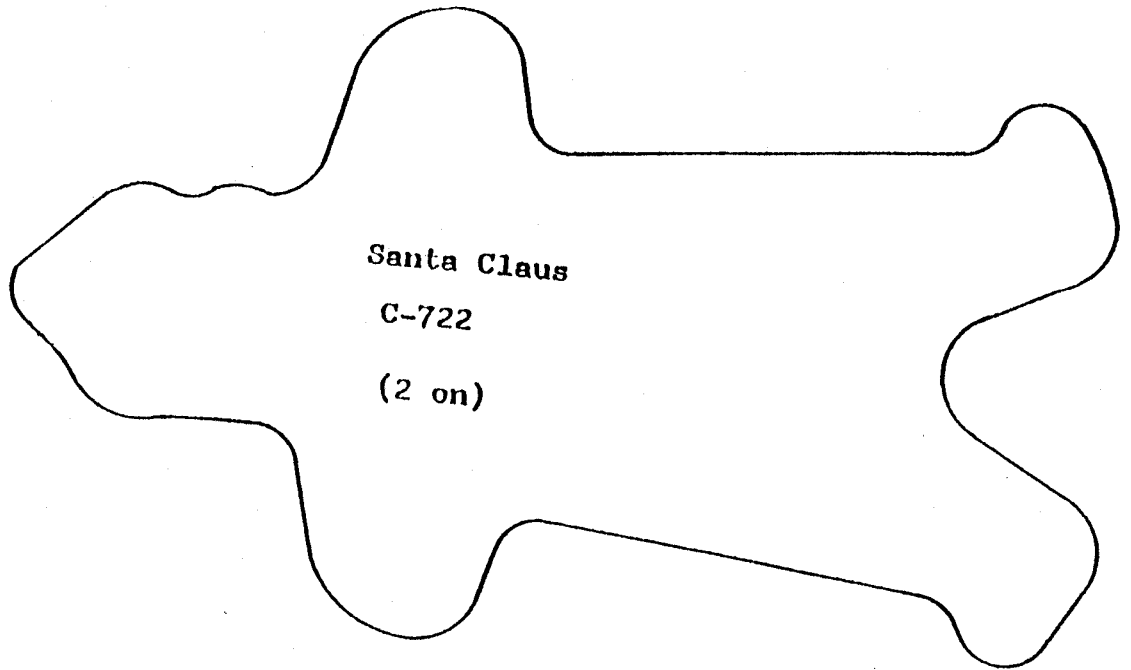

C-621 (7 on)

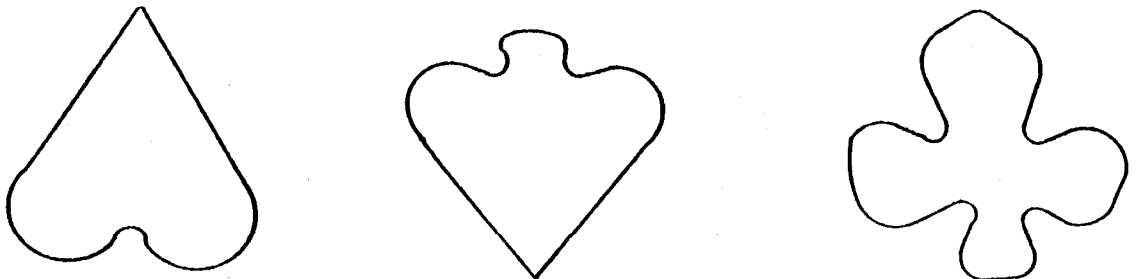

ABOVE ALL ON ONE (1) DIE

16" WIDE EXTRUDER / DEPOSITOR DIES

(ALL ILLUSTRATION ACTUAL SIZE)

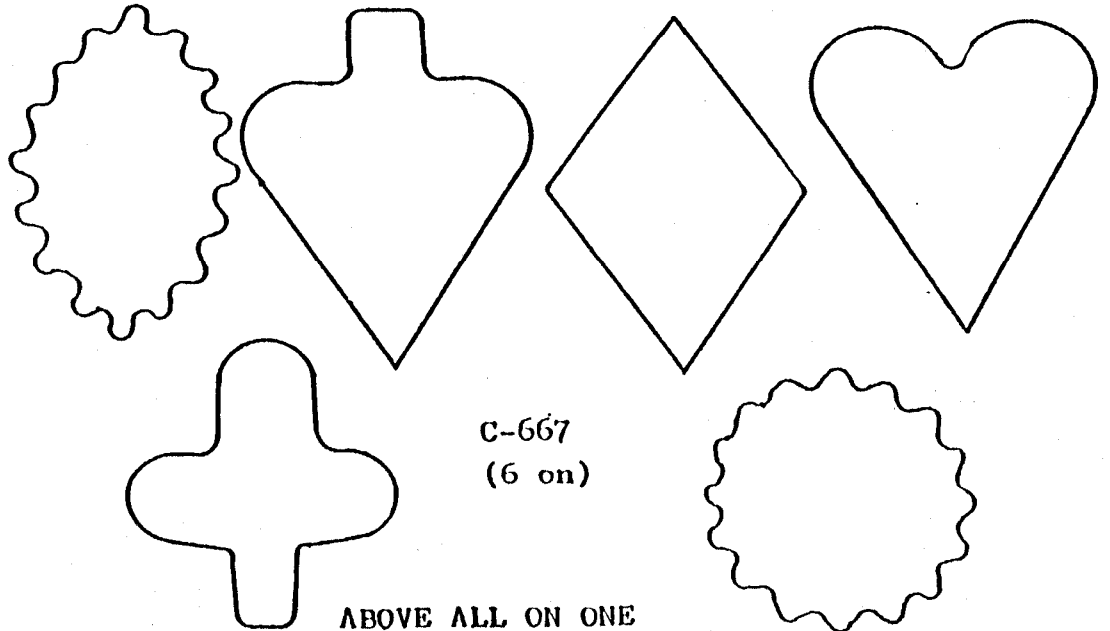

ABOVE ALL ON ONE
(1) DIE

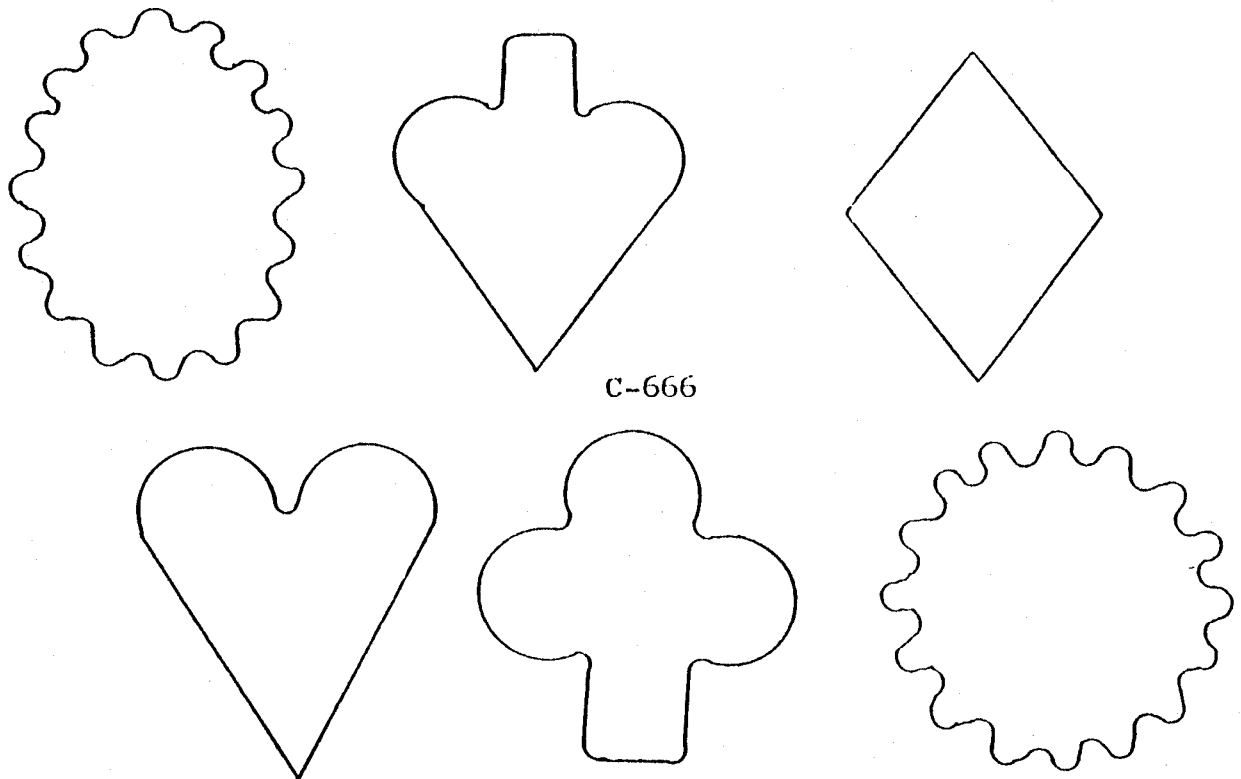

ABOVE ALL ON ONE (1) DIE

16" WIDE EXTRUDER / DEPOSITOR DIES

(ALL ILLUSTRATION ACTUAL SIZE)

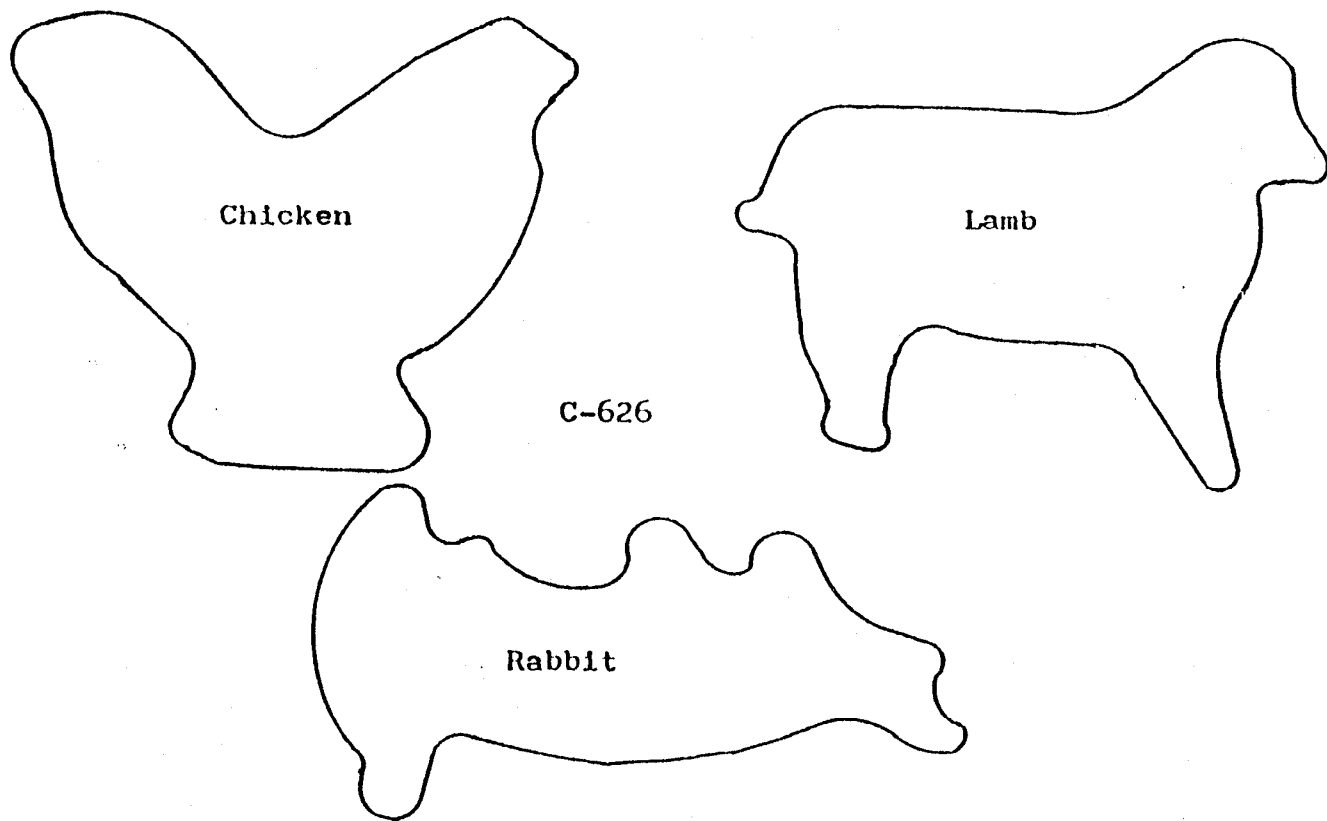

ABOVE ALL ON ONE (1) DIE

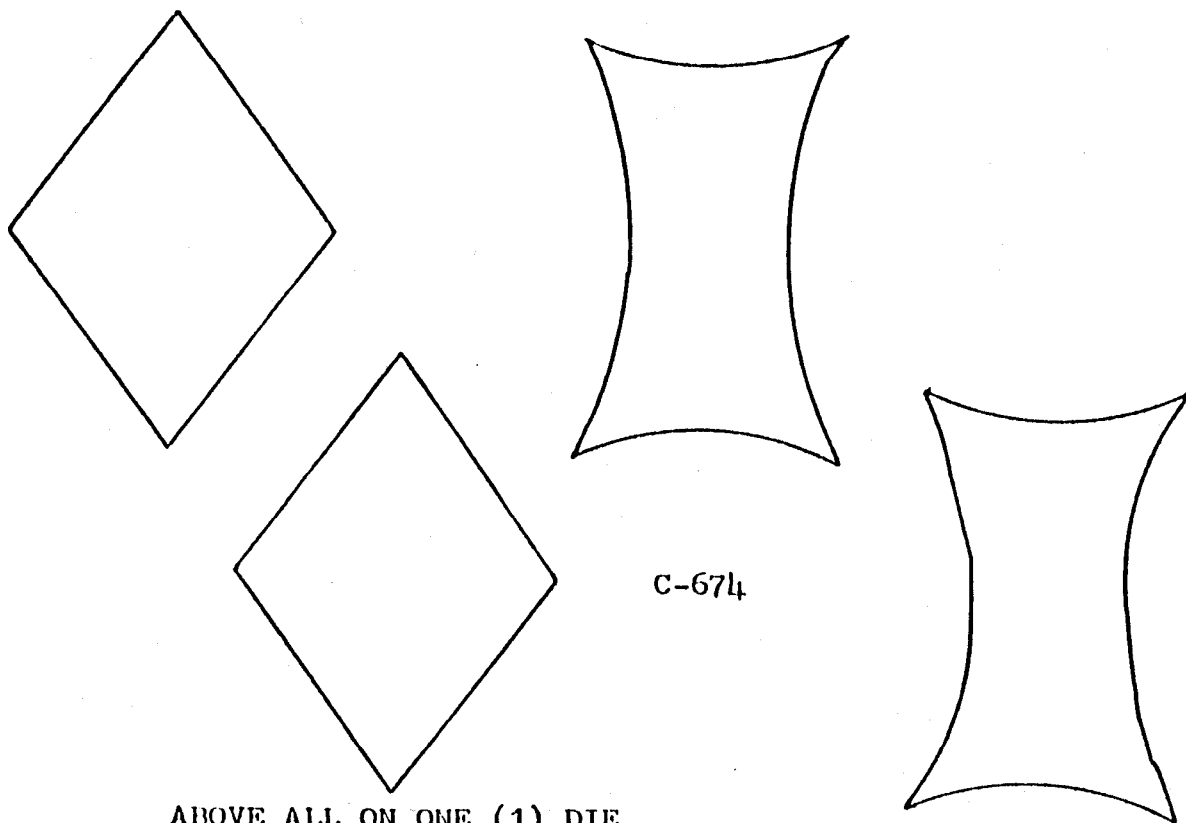

ABOVE ALL ON ONE (1) DIE